

Article number: 20133B40B202SW  
 Description: E+G Two-way Connector  
 GN133-B40-B20-2-SW

## Measures

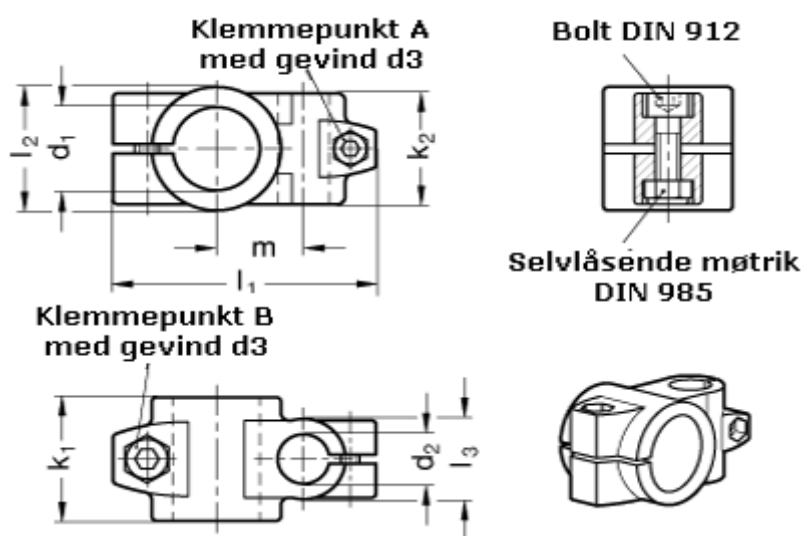

Adjustable clamp lever for d3 = GN 911-M10-55 have to be ordred separately

Adjustable clamp lever for d4 = GN 911-M 8-32 have to be ordred separately

d1 = 40  
 d2 = 20  
 d3 = M10  
 d4 = M 8  
 k1 = 65  
 k2 = 59

l1 = 122.0

l2 = 65

l3 = 40

m = 45